



MAXIMOVER
Intermediate Bulk Containers

UK MANUFACTURED
Intermediate Bulk Containers

As a leading supplier of Intermediate Bulk Containers, Mailbox Stamford Products Limited offers you expertise and experience gained from over 50 years of solving problems in the handling of industrial materials.

We provide an extensive range of units for the bulk storage and transportation of non hazardous solids and liquids.

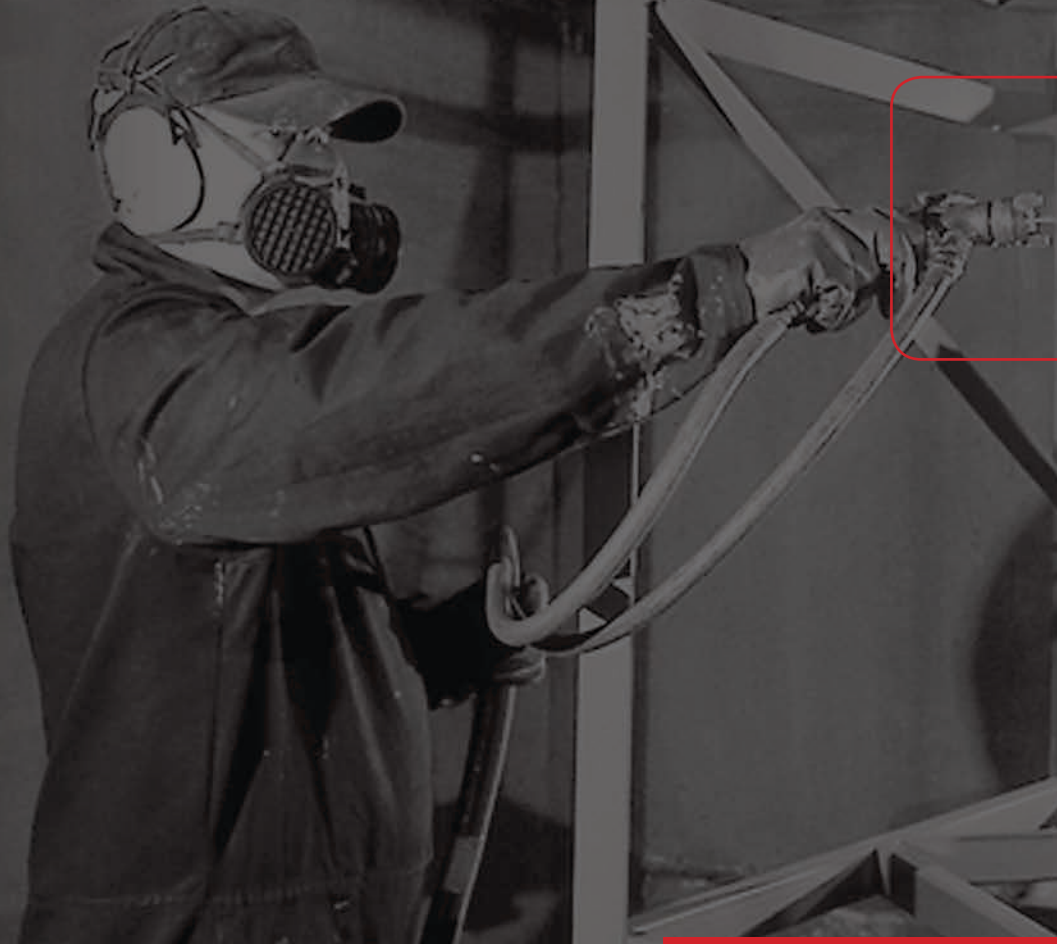

UK Manufacturing



Concept design
& variations



CUSTOM UK MANUFACTURING

Flexibility in design

From our North West head office and factory we offer the flexibility to manufacture bespoke Maximover designs to your precise specifications including: size, materials, accessories, finish options and logo personalisation.



NON-HAZARDOUS LIQUIDS

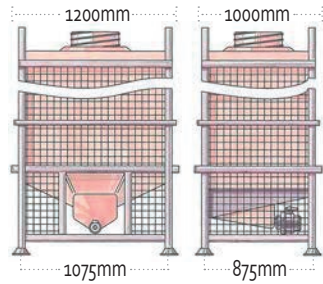

LIQUID IBC

Specifically for transportation of bulk liquids

Based on European pallet dimensions of 1200mm x 1000mm enabling two wide and two high to fit on many commercial vehicles.

KLT RANGE

Standard fittings:

350mm screw lid with 2" single union ball valve for liquids.
Optional galvanised frame for extended external use.

MODEL	CAPACITY	HEIGHT	WIDTH	DEPTH	MATERIAL
KLT0700	700 litres	1370mm	1200mm	1000mm	MDPE
KLT0800	800 litres	1470mm	1200mm	1000mm	MDPE
KLT0900	900 litres	1570mm	1200mm	1000mm	MDPE
KLT1000	1000 litres	1670mm	1200mm	1000mm	MDPE
KLT1100	1100 litres	1770mm	1200mm	1000mm	MDPE
KLT1200	1200 litres	1870mm	1200mm	1000mm	MDPE

PART No	DESCRIPTION	Pages 17-19 for accessory details.
---------	-------------	------------------------------------

OPTIONAL LIDS:

- ON0073 150mm (GRPP) screw lid with captive gasket for leak-proof seal.
- OW0025 380mm(PE) hinged lid - ensures lid assembly is retained with the IBC.

OPTIONAL VALVES: Page 17 for Camlocking adaptors and couplings.

- ON0043 2" (PVC) single union ball valve - quick operating 90° action.
- OC0007 2" polypropylene flange adaptor.
- ON0076 2" brass ball valve - metal valve for heavy duty applications.
- SB10110 3" brass ball valve - metal valve for heavy duty applications.
- BP1156 2" stainless steel butterfly valve - for hygienic applications.
- ON0074 1.5"(GRPP) double union ball valve - high quality valve with lockable handle.
- BP1045 2"(GRPP) double union ball valve - high quality valve with lockable handle

OPTIONAL VENT:

- ON0048 Anti-pressure, Anti-vacuum or Dual action.

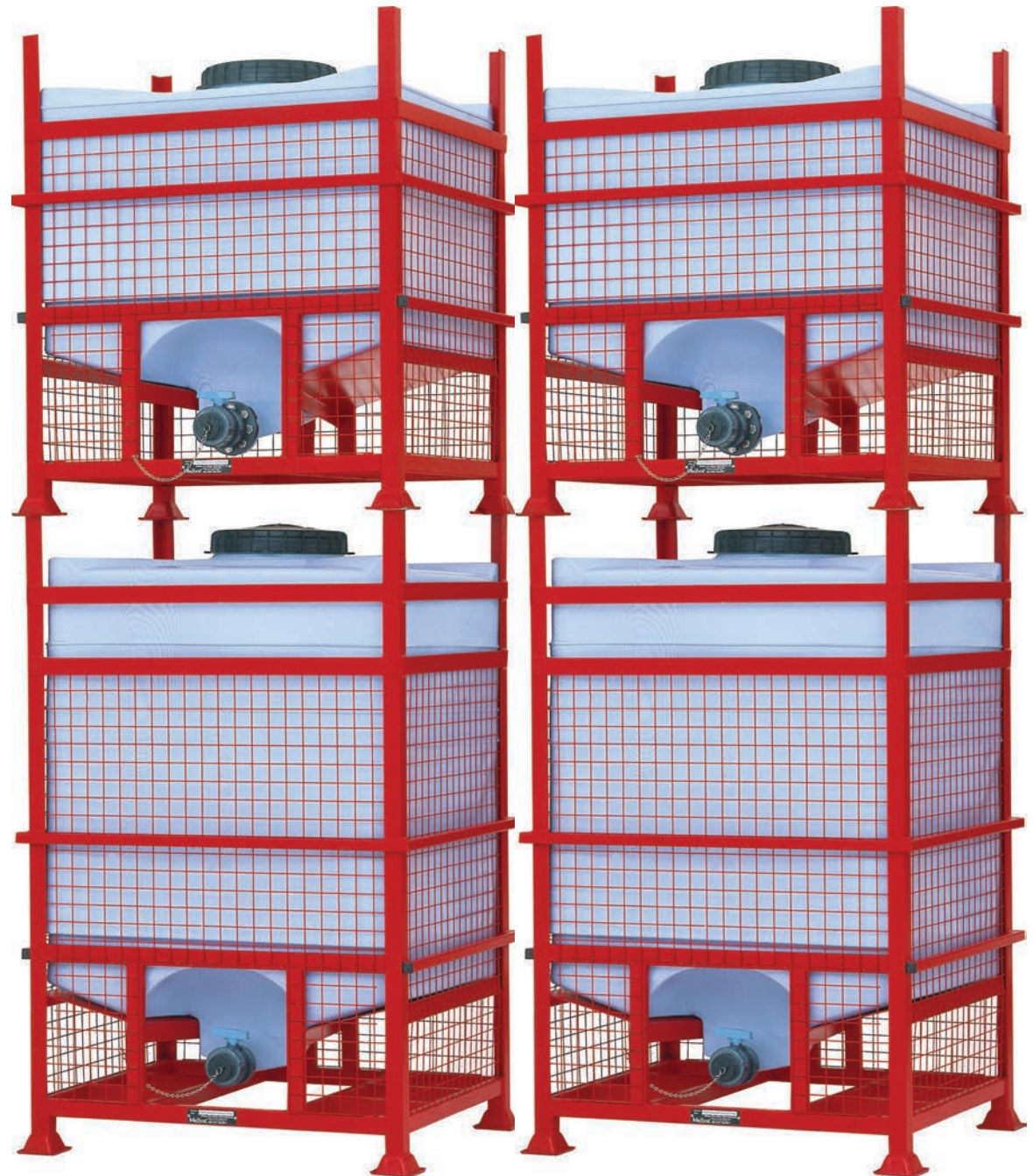

Available without mesh or fully sheeted for liner protection.



Foam storage with
custom housing

KLT 1100 LITRE MAXIMOVERS Developed with the local Fire Fighting Service

Fire-retardant foams use organic solvent to suppress emergency situations; safe and reliable transportation of the foam from the manufacturer to the fire station is paramount.



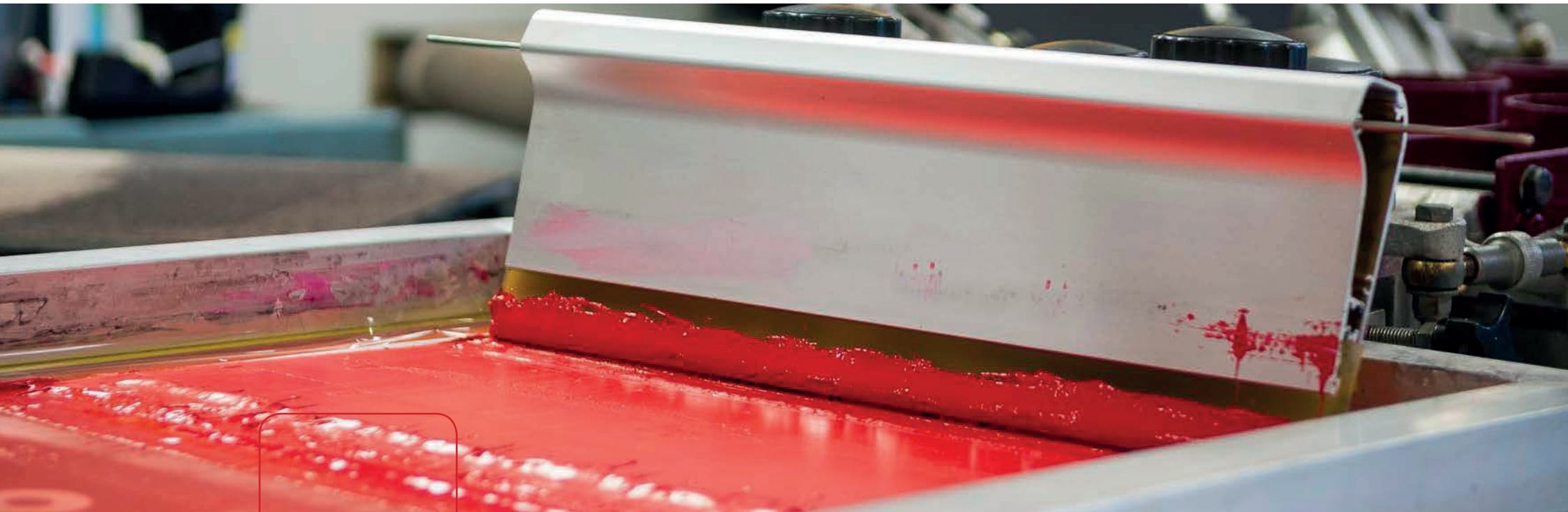

Store paints used
for print production

VERSATILE MAXIMOVER

Transform your storage and handling operations

We provide the best solutions for storage and transportation of bulk goods in a wide range of sizes and shapes for industrial use, reducing handling, transportation and packaging costs in the process.

LIQUID IBC

All-round Maximover from 600 to 2000 litres

Inherently strong cylindrical construction for the handling and transportation of bulk liquids of high s.g. or high viscosity.

All units have a choice of 2"/3" vertical or horizontal, flanged or spigot outlet.

KLC RANGE

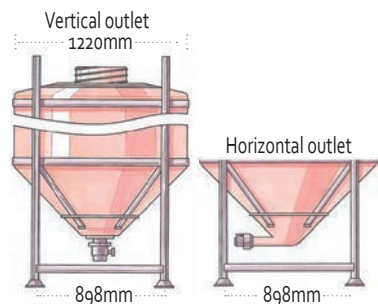

Standard fittings:

350mm screw lid with 2" single union ball valve for liquids.
Optional galvanised frame for extended external use.

MODEL	CAPACITY	HEIGHT	WIDTH	DEPTH	MATERIAL
KLC0600	600 litres	1440mm	1220mm	1220mm	MDPE
KLC1000	1000 litres	1846mm	1220mm	1220mm	MDPE
KLC1500	1500 litres	2290mm	1220mm	1220mm	MDPE
KLC2000	2000 litres	2740mm	1220mm	1220mm	MDPE

PART No DESCRIPTION Pages 17-19 for accessory details.

OPTIONAL LIDS:

ON0073	150mm (GRPP) screw lid with captive gasket for leak-proof seal.
OW0025	380mm(PE) hinged lid - ensures lid assembly is retained with the IBC.
OW0004	480mm (PE) clamp lid with galvanised band (optional chain).

OPTIONAL VALVES: Page 17 for Camlocking adaptors and couplings.

ON0043	2" (PVC) single union ball valve - quick operating 90° action.
OC0007	2" polypropylene flange adaptor.
ON0076	2" brass ball valve - metal valve for heavy duty applications.
SB10110	3" brass ball valve - metal valve for heavy duty applications.
BP1156	2" stainless steel butterfly valve - for hygienic applications.
ON0074	1.5"(GRPP) double union ball valve - high quality valve with lockable handle.
BP1045	2"(GRPP) double union ball valve - high quality valve with lockable handle

OPTIONAL VENT:

ON0048	Anti-pressure, Anti-vacuum or Dual action.
--------	--





NON- HAZARDOUS LIQUIDS

KLS RANGE

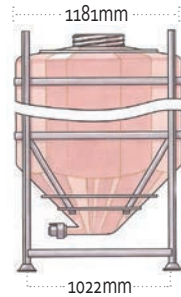

Standard fittings:

350mm screw lid with 2" single union ball valve for liquids.
Optional galvanised frame for extended external use.

MODEL	CAPACITY	HEIGHT	WIDTH	DEPTH	MATERIAL
KLS0500	500 litres	1280mm	1181mm	1181mm	MDPE
KLS0750	750 litres	1480mm	1181mm	1181mm	MDPE
KLS1000	1000 litres	1680mm	1181mm	1181mm	MDPE
KLS1250	1250 litres	1880mm	1181mm	1181mm	MDPE
KLS1500	1500 litres	2080mm	1181mm	1181mm	MDPE
KLS1750	1750 litres	2280mm	1181mm	1181mm	MDPE
KLS2000	2000 litres	2480mm	1181mm	1181mm	MDPE
KLS2250	2250 litres	2680mm	1181mm	1181mm	MDPE
KLS2500	2500 litres	2880mm	1181mm	1181mm	MDPE
KLS2750	2750 litres	3080mm	1181mm	1181mm	MDPE
KLS3000	3000 litres	3280mm	1181mm	1181mm	MDPE

PART No **DESCRIPTION** **Pages 17-19 for accessory details.**

OPTIONAL LIDS:

- OW0025 380mm(PE) hinged lid - ensures lid assembly is retained with the IBC.
- OW0004 480mm (PE) clamp lid with galvanised band (optional chain).
- OW0026 Large (PE) drop-on lid.

OPTIONAL VALVES: Page 17 for Camlocking adaptors and couplings.

- ON0043 2" (PVC) single union ball valve - quick operating 90° action.
- OC0007 2" polypropylene flange adaptor.
- ON0076 2" brass ball valve - metal valve for heavy duty applications.
- SB10110 3" brass ball valve - metal valve for heavy duty applications.
- BP1156 2" stainless steel butterfly valve - for hygienic applications.
- ON0074 1.5"(GRPP) double union ball valve - high quality valve with lockable handle.
- BP1045 2"(GRPP) double union ball valve - high quality valve with lockable handle

OPTIONAL VENT:

- ON0048 Anti-pressure, Anti-vacuum or Dual action.



KLC 0227 - LIQUIDS

Standard fittings:

350mm screw lid with 2" single union ball valve for liquids.
Optional galvanised frame for extended external use.

MODEL	CAPACITY	HEIGHT	WIDTH	DEPTH	MATERIAL
KLC0227	227 litres	1041mm	806mm	806mm	MDPE

PART No DESCRIPTION Pages 17-19 for accessory details.

OPTIONAL LID:

OW0004 480mm (PE) clamp lid with galvanised band (optional chain).

OPTIONAL VALVES: Page 17 for Camlocking adaptors and couplings.

ON0043 2" (PVC) single union ball valve - quick operating 90° action.

OC0007 2" polypropylene flange adaptor.

OPTIONAL VENT:

ON0048 Anti-pressure, Anti-vacuum or Dual action.

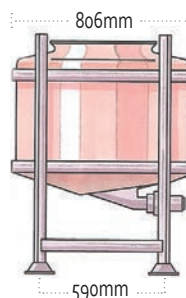

KLS 0430 - 90° CONE-LIQUIDS

Standard fittings:

350mm screw lid with 2" single union ball valve for liquids.
Optional galvanised frame for extended external use.

MODEL	CAPACITY	HEIGHT	WIDTH	DEPTH	MATERIAL
KLS0430	430 litres	1538mm	743mm	743mm	MDPE

PART No DESCRIPTION Pages 17-19 for accessory details.

OPTIONAL LID:

OW0004 480mm (PE) clamp lid with galvanised band (optional chain).

OPTIONAL VALVES: Page 17 for Camlocking adaptors and couplings.

ON0043 2" (PVC) single union ball valve - quick operating 90° action.

OC0007 2" polypropylene flange adaptor.

ON0076 2" brass ball valve - metal valve for heavy duty applications.

BP1156 2" stainless steel butterfly valve - for hygienic applications.

ON0074 1.5" (GRPP) double union ball valve - high quality valve with lockable handle.

BP1045 2" (GRPP) double union ball valve - high quality valve with lockable handle.

OPTIONAL VENT:

ON0048 Anti-pressure, Anti-vacuum or Dual action.

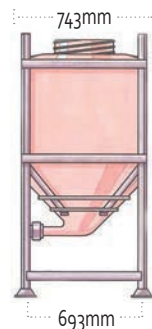



Food production
and storage

SAFE SECURE PACKAGING

Creating neater and cleaner working environments

Our containers are widely used across the food and beverage industries due to the strong, sturdy and hygienic qualities of our Maximover IBC range.

Bright colours are available for fast container and content identification in food preparation areas.

KSS-90° CONE (200mm outlet)

- 1.5 cubic metre capacity.
- Robust build, frustum styled support.
- Two-way heavy duty fork lift access points.
- 200mm dia double flange slide valve fitted with transit cover.
- Nominal 500mm dia inlet port which is closed with a lid toggle action steel clamp.

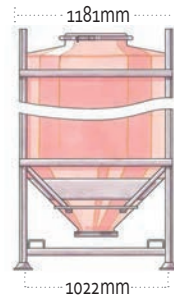

NON-HAZARDOUS
SOLIDS

Standard fittings:

**480mm (PE) clamp lid with galvanised band.
200mm double flanged slide valve and transit cap.**

MODEL	CAPACITY	HEIGHT	WIDTH	DEPTH	MATERIAL
KSS1500	1.5 Cu. m	2030mm	1181mm	1181mm	MDPE

PART No **DESCRIPTION** Pages 17-19 for accessory details.

OPTIONAL LIST:

ON0090 350mm (PE) screw lid ensures lid assembly is retained with IBC.

OPTIONAL VENT:

ON0048 Anti-pressure, Anti-vacuum or Dual action.



NON-HAZARDOUS SOLIDS

KSS - 90° & 60° CONES (200mm & 300mm outlet)

Standard fittings:

350mm screw lid with 90° & 60° single flanged slide valve.
Optional galvanised frame for extended external use.

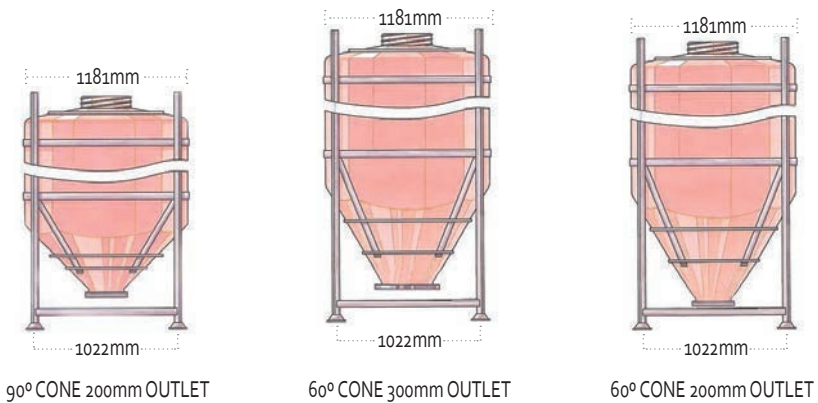

Single 0.10 C.u.m capacity expansion can be fitted to standard range units - add 100mm to overall height.

MODEL	CAPACITY	HEIGHT			WIDTH	DEPTH	MATERIAL
		90° CONE 200mm OUTLET	60° CONE 300mm OUTLET	60° CONE 200mm OUTLET			
KSS0500	0.50 Cu. m	1260mm	1480mm	N/A	1181mm	1181mm	MDPE
KSS0750	0.75 Cu. m	1460mm	1680mm	1880mm	1181mm	1181mm	MDPE
KSS1000	1.00 Cu. m	1660mm	1830mm	2080mm	1181mm	1181mm	MDPE
KSS1250	1.25 Cu. m	1860mm	2030mm	2280mm	1181mm	1181mm	MDPE
KSS1500	1.50 Cu. m	2060mm	2230mm	2480mm	1181mm	1181mm	MDPE
KSS1750	1.75 Cu. m	2260mm	2480mm	2680mm	1181mm	1181mm	MDPE
KSS2000	2.00 Cu. m	2460mm	2680mm	2880mm	1181mm	1181mm	MDPE
KSS2250	2.25 Cu. m	2660mm	2880mm	3080mm	1181mm	1181mm	MDPE
KSS2500	2.50 Cu. m	2860mm	3080mm	3280mm	1181mm	1181mm	MDPE
KSS2750	2.75 Cu. m	3060mm	3280mm	3480mm	1181mm	1181mm	MDPE
KSS3000	3.00 Cu. m	3260mm	3480mm	3680mm	1181mm	1181mm	MDPE

PART No DESCRIPTION Pages 17-19 for accessory details.

OPTIONAL LIDS:

ON0073	150mm (GRPP) screw lid with captive gasket for leak-proof seal.
OW0025	380mm(PE) hinged lid - ensures lid assembly is retained with the IBC.
OW0004	480mm (PE) clamp lid with galvanised band (optional chain).
OW0024	500mm (PE) push fit lid - Easy access for cleaning.
OW0026	Large (PE) drop-on lid.

OPTIONAL VALVES:

SP0002	200mm double flanged slide valve.
SP10130	300mm double flanged slide valve.
ON0033	200mm polynylon sleeve with back ring .
OC0018	200mm mucon valve iris diaphragm for improved flow control.
SB10151	300mm mucon valve iris diaphragm for improved flow control.
SB10494	200mm light nylon sleeve to suit single flanged mucon valve.

OPTIONAL VENT:

ON0048	Anti-pressure, Anti-vacuum or Dual action.
--------	--



SOLID IBC

All-round Maximover from 0.6 to 2.0 Cu. m

KSC- 90° & 60° CONES (200mm & 300mm outlet)

NON-HAZARDOUS SOLIDS

Standard fittings:

350mm screw lid with 200mm / 300mm single flanged slide valve.
Optional galvanised frame for extended external use.

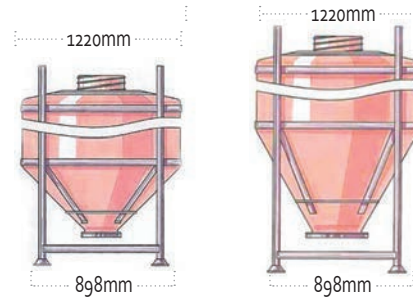

90° CONE 200mm OUTLET

60° CONE 300mm OUTLET

MODEL	CAPACITY	HEIGHT		WIDTH	DEPTH	MATERIAL
		90° CONE 200mm OUTLET	60° CONE 300mm OUTLET			
KSC0600	0.60 Cu. m	1365mm	1395mm	1220mm	1220mm	MDPE
KSC1000	1.00 Cu. m	1771mm	1810mm	1220mm	1220mm	MDPE
KSC1500	1.50 Cu. m	2215mm	2245mm	1220mm	1220mm	MDPE
KSC2000	2.00 Cu. m	2665mm	2695mm	1220mm	1220mm	MDPE

PART No DESCRIPTION Pages 17-19 for accessory details.

OPTIONAL LIDS:

ON0073	150mm (GRPP) screw lid with captive gasket for leak-proof seal.
OW0025	380mm(PE) hinged lid - ensures lid assembly is retained with the IBC.
OW0004	480mm (PE) clamp lid with galvanised band (optional chain).

OPTIONAL VALVE OUTLETS:

SP0002	200mm double flanged slide valve.
SP10130	300mm double flanged slide valve.
ON0033	200mm polynylon sleeve with back ring .
OC0018	200mm mucon valve iris diaphragm for improved flow control.
SB10151	300mm mucon valve iris diaphragm for improved flow control.
SB10494	200mm light nylon sleeve to suit single flanged mucon valve.

OPTIONAL VENT:

ON0048	Anti-pressure, Anti-vacuum or Dual action.
--------	--



**NON-HAZARDOUS
SOLIDS**

KSC 0227 (200mm outlet)

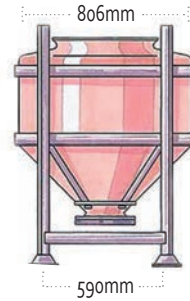

Standard fittings:

**350mm screw lid with 200mm single flanged slide valve.
Optional galvanised frame for extended external use.**

MODEL	CAPACITY	HEIGHT	WIDTH	DEPTH	MATERIAL
KSC0227	0.227 Cu. m	1073mm	806mm	806mm	MDPE

PART No	DESCRIPTION
---------	-------------

OPTIONAL LID: Pages 17-19 for accessory details.

OW0004 480mm (PE) clamp lid with galvanised band (optional chain).

OPTIONAL VALVES:

SP0002 200mm double flanged slide valve outlet.

OC0018 200mm mucon iris diaphragm valve for improved flow control.

ON0033 200mm poly nylon sleeve - use with slide valve.

SB10494 200mm light nylon sleeve - use with mucon valve.

OPTIONAL VENT:

ON0048 Anti-pressure, Anti-vacuum or Dual action.





DISPENSING UNITS

Custom made units for liquid or solids

Full welded 2-5 bank units capacities from 200-3000 litres.

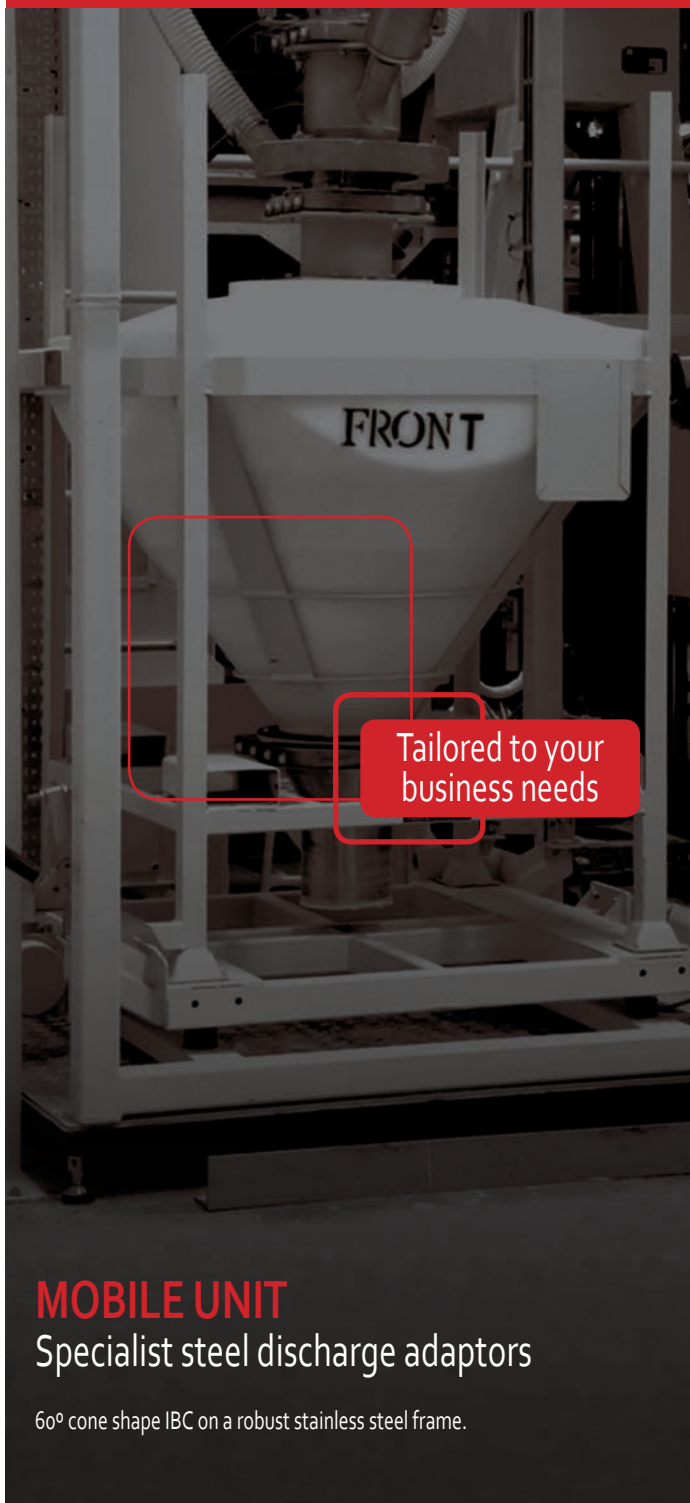

MOBILE UNIT

Specialist steel discharge adaptors

60° cone shape IBC on a robust stainless steel frame.



PLASTIC DOSING SYSTEM

Developed for industrial dispensing

Solid granules and powders are housed in the 1.5 Cu.m containers feeding the production line for product colour mixing of master batches.

CONSULTATION & INSTALLATION

Free production line assessment

Storage area assessment from our materials handling representatives to help produce bespoke solutions implementing the best practices.



Capacities from
200 - 3000 litres

MAXIMOVER ACCESSORIES

Ball valve, camlocking adaptors and couplers

Maximover units combine with a range of valve fittings to improve flow and eliminate problem spillages. Approved for hygienic applications within the food and pharmaceutical industries.

Eliminate
spillage risks

Valves for liquids (standard and optional)



ON0043
2" (PVC) single union
Ball valve polypropylene for improved impact and chemical resistance.



ON0076 - (2" code) SB10110 - (3" code)
2" / 3" brass ball valve, Metal valve for heavy duty applications.

Optional Brass flange adaptor: as shown
ON0028 - (2" code) ON0030 - (3" code)



BP1156 - (2" code)
2" butterfly valve in Stainless steel, with flange adaptor. Hygienic applications within food and pharmaceutical industries.



OC0007
2" polypropylene flange adaptor.



Valves for liquids (standard and optional)



ON0074 - (1.5" code) BP1045 - (2" code)
(GRPP) valve Double union high quality
valve with lockable handles and choice of
integral BSP or camlocking outlet ports.



SP0011
2" (GRPP) Male camlock.



SP0012
2" (GRPP) male cap.



SP0013
2" (GRPP) male camlock and
hosetail.



ON0042
2" (GRPP) bulk head fitting and back nut.

Lids (standard and optional)



ON0073
150mm (GRPP) screw lid
Captive gasket for a leak-proof seal.



ON0083
220mm (GRPP) screw lid
Captive gasket for a leak-proof seal.



ON0090
350mm (GRPP) wide screw lid
For easy filling gasket ensures a leak-
proof seal.



OW0025
380mm (PE) hinged lid
Ensures lid assembly is always
retained with IBC.



OW0024
500mm (PE) push fit lid
Allows easy access for cleaning.



OW0026
Large (PE) drop-on lid
Allows complete access to unit,
cover prevents contamination.



OW0004 - 480mm (PE) clamp lid
ON0006 - Galvanised band (optional chain).

Valves for solids (standard and optional)

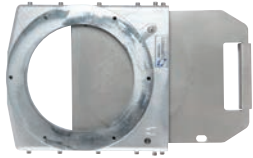

OC0025 - (200mm code)
SP0003 - (300mm code)

Single flanged slide valve outlet
flange allows additional attachment
or sealing to underside of valve.



ON0033
200mm Poly nylon sleeve
Complete with back ring to suit
double flanged slide valve
Length can be specified.



OC0018 - (200mm code)
SB10151 - (300mm code)

Iris diaphragm valve for improved flow
control and seal.



SB10494
200mm light nylon sleeve
To suit single flanged mucon valve.
Can be fed through diaphragm.
Length can be specified.



ON0048
Anti-pressure vent.
Anti-vacuum or dual action.

SP0002 - (200mm code)
SP10130 - (300mm code)

Double flanged slide valve outlet
flange allows additional attachment
or sealing to underside of valve.

ACCESSORIES

Additional innovative fittings are available on request,
please contact our Maximover specialists with your requirements.

Vents (optional)





MAXIMOVER

Intermediate Bulk Containers

Bayley Street, Stalybridge, Cheshire, SK15 1QQ

Tel: +44 (0)161 330 5577 Fax: +44 (0)161 330 5576 Email: sales@mailboxproducts.co.uk

Please visit: www.mailboxproducts.co.uk

A member of The Stamford Group of Companies.

Mailbox
www.mailboxproducts.co.uk